

Aoralscan 3

WIRELESS

Intraoral Scanner

Scan Without Limits



WIRELESS EFFORTLESS LIMITLESS



Go Wireless

Provides a more comfortable experience for dentist and patient without restraints from a wired setup.



Fast and Stable

Built-in Wi-Fi 6 technology enables a seamless scan experience with fast and stable data transmission.



Long-lasting Battery Life

Up to **2 hours** of continuous scanning for each charge, with **3 batteries** included. Enjoy smooth scanning and a seamless workflow with a long battery life.



Next-level Software Functions

Faster data post-processing speed. Self-developed, clinic-friendly functions, including Orthodontic Simulation, Model Creator, Temp Design, Indirect Bonding Tray Design, Oral Health Report and Data Track.



Autoclavable
100 times.

A photograph of a grey, cylindrical dental scanning probe. A vertical blue line with a dot at the top points to the probe, and a horizontal blue line with a dot at the left end points to the text above.

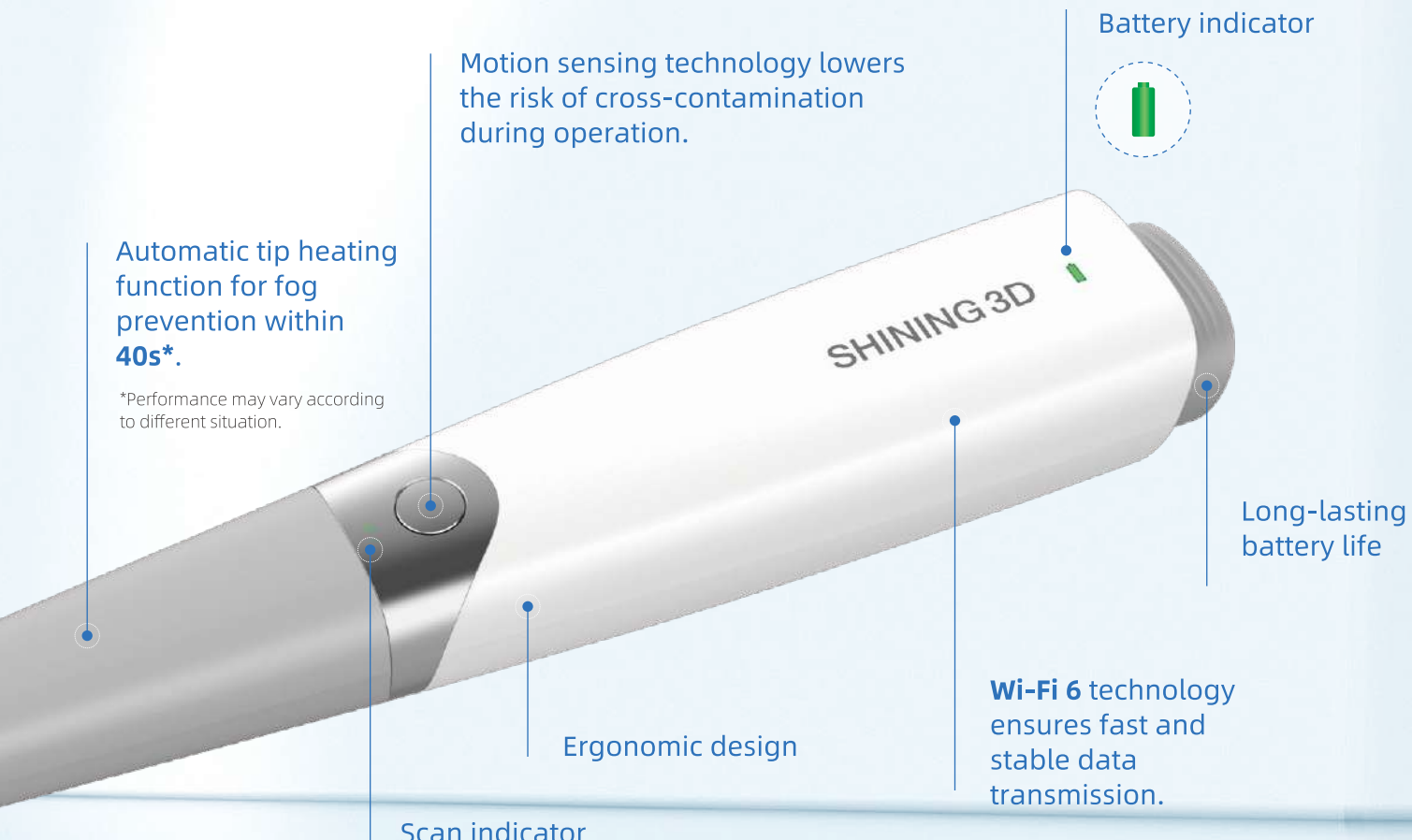

Battery indicator



Motion sensing technology lowers the risk of cross-contamination during operation.

Automatic tip heating function for fog prevention within **40s***.

*Performance may vary according to different situation.

Long-lasting battery life

Wi-Fi 6 technology ensures fast and stable data transmission.

Ergonomic design

Scan indicator



Dual-size Tips
Adult and Pediatric

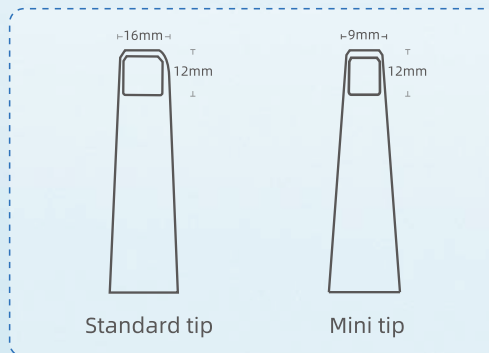



AORALSCAN 3 GOES WIRELESS

- No constraints of cables. Enjoy the freedom of wireless scanning.
- Equipped with the latest Wi-Fi 6 technology, the AoralScan 3 Wireless gives you the same fast scanning experience as a wired connection without lag.
- AoralScan 3 Wireless provides reliable, consistent, and accurate scan output.

WIRELESS

LONG-LASTING BATTERY LIFE

Each scanner is equipped with **3 batteries** and a **charging hub** for non-stop scanning.



2 hours of continuous scanning.



10 days under standby mode.



One case scanning time: **2min***
(Maxillary + mandibular + occlusion)

*Performance may vary according to different situation.



1 charge can be utilized for up to **60 cases**.

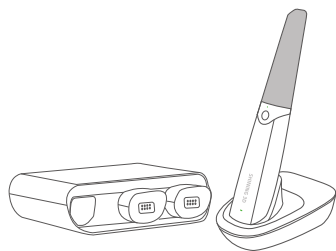
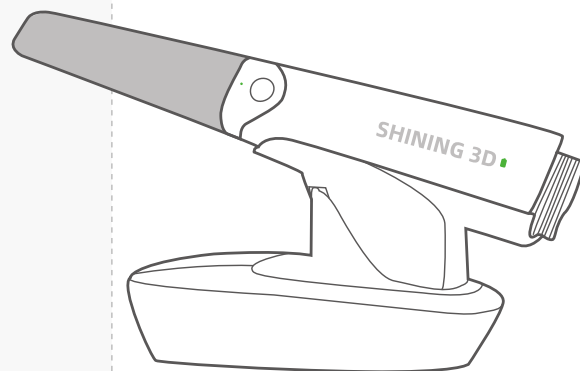

Charging cradle

When finished scanning, you can put the Aoralscan 3 Wireless back onto the cradle to charge.

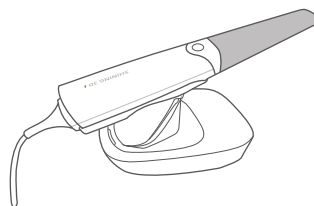

Wired connection

Wired scan option is included as well.

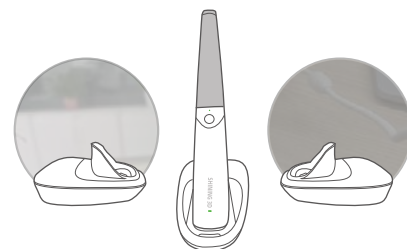

Multi-cradle adaptable

The scanner can adapt to multiple cradles. Pick up the device and switch between multiple chairs.





POWERFUL SCAN

AI Scanning

Automatically identifies and filters out miscellaneous data, resulting in a quicker and neater scan process.



Motion Sensing

Scans with minimal contact with computer, ensuring a safe and efficient scan experience.



Refined Scan

Refines the restoration area to help obtain clear margin data and more detailed surface data.

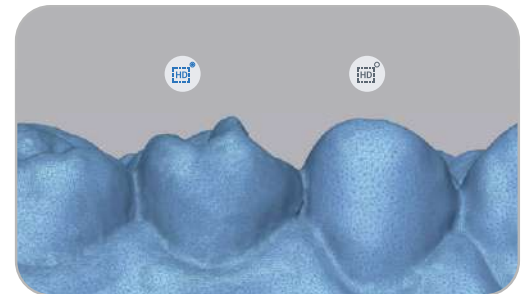

SCANNING ASSISTANCE

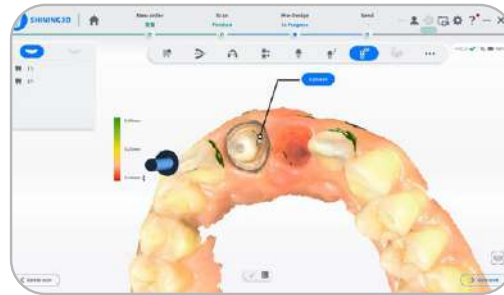

Undercut Check

During the scanning process, the undercut value can be displayed for easy judgment by the dentist.



Bite Check

Ensures accurate occlusal relationship for subsequent applications.

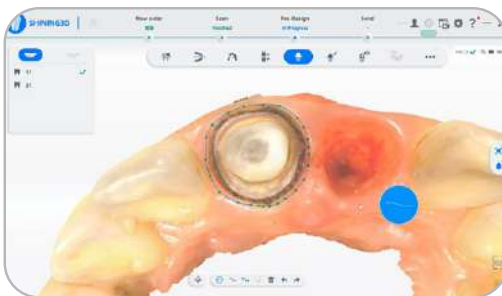

Margin Line Auto Extraction

Allows quick identification of margin lines, which helps communication between dentist and technician.

NEXT-LEVEL SOFTWARE FUNCTIONS

Ortho Simulation

The whole treatment process can be simulated and patient will be able to see the post-treatment effect in advance, extremely effective for consultation process.



Oral Health Report

Visually demonstrates patients' comprehensive oral health condition, dramatically improving dentist-patient communication efficiency.



Model Creator

Orthodontic or restoration models can be easily designed for following printing process.

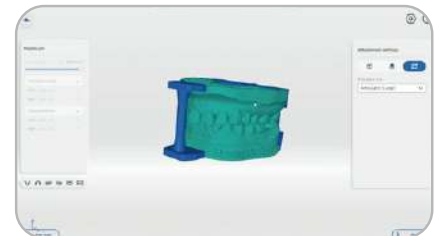

Temp Design

Temporary crowns can be designed and printed in the office, reducing the patient's waiting time.

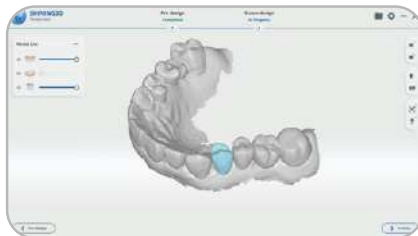

IBT Design

Designs indirect bonding tray, which can be directly 3D printed to help orthodontists attach brackets faster and more accurately.

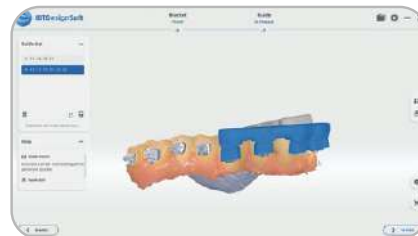

Data Track

Helps patients understand oral changes and improve the efficiency of dentist-patient communication by tracking patient data.

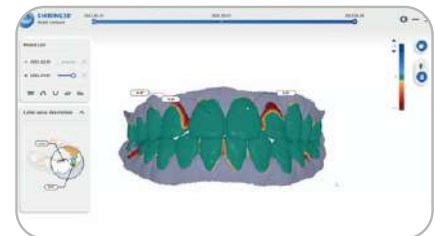

SHINING 3D DENTAL CLOUD

Optimal Dentist-Technician Collaboration

Standard and Unlimited - Seamless Collaboration between Dentists and Technicians
Shining 3D Dental Cloud allows for data transfer and communication between dental clinics and labs.



Dashboard

Visual data management center to assist institutional management.



Data Assessment

Streamlines scan data confirmation process between dentists and technicians.



Patient Management

Convenient tool to check patients' past medical records at any time.



Printer Management

Monitors and manages the printers in real time to improve production efficiency.

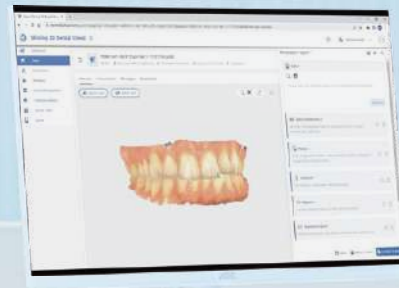

Technical Specifications

Aoralscan 3 Wireless

Scan Field	Standard scanner tip: 16 mm × 12 mm × 22 mm Mini scanner tip: 12 mm × 9 mm × 22 mm
Scan Depth	-2mm to 20 mm from exit surface of tip
Scan Tip Sterilization	Autoclave 100 times 121°C 102.9kPa 30 mins 134°C 205.8kPa 4 mins
Scan Tip Heating	40s instant heating(Anti-fogging)
Scan Principle	Non-contact scanning with the structured light
Wireless Technology	Wi-Fi 6(802.11a/n/ac/ax)
Effective Wireless Range	Same room, up to 5m
Battery Life	2 hours of continuous scanning. 10 days standby mode
Dimension (L * W * H)	270(L)x50(W)x40(H)mm(includes battery, tip)
Total Weight	330±20g(includes battery, tip)
Output	STL, OBJ, PLY
Connector	USB 3.0
Power Input	12V DC/3A

Recommended PC Configuration

CPU	Intel® Core™ i7-11700H / Intel® Core™ i7-10700F Minimum: Intel® Core™ i7-8700F / Recommend: Intel® Core™ i7-11800H
Memory	Minimum: 16GB / Recommend: 32GB
Hard Disk Drive	Minimum: 256GB SSD / Recommend: 2TB SSD
Graphic Card (GPU)	NVIDIA RTX 2060/2070/3060/3070/3080
Operating System	Windows 10/11 Professional (64-bit)
Display Resolution	1920 * 1080, 60Hz or higher
I/O Ports	More than 2 type-A USB 3.0 (or higher) ports



sales@shining3d.com
www.shining3ddental.com